

# PIUR IMAGING

## PIUR<sup>®</sup> tUS Infinity

### User Manual



# User Manual

## PIUR® tUS Infinity

Document Revision 15.0

Software version: 4.1

Type: PIUR tUS Infinity

© piur imaging GmbH

This User Manual may neither be partly nor fully copied, reproduced by any other means or translated into another language without prior written consent from piur imaging GmbH.

The manufacturer reserves the right to amend the information in this User Manual without announcement.

© 2024 piur imaging GmbH  
Hamburgerstrasse 11 / TOP7  
1050 Vienna  
Austria

## Table of Contents

1	General Information .....	5
1.1	Abbreviations and Terms .....	5
1.2	Symbols in User Manual .....	5
1.3	Symbols on device.....	5
1.3.1	Identification Label .....	6
1.4	Function of this Document.....	9
1.5	Intended Use.....	10
1.6	Disclaimer.....	10
1.7	General Residual Risk including significant Risks .....	10
1.8	Recommendations regarding cybersecurity:.....	11
1.9	Contact and Regulatory Information.....	11
2	Safety Regulations.....	12
2.1	User Requirements for Use.....	14
3	Product Information .....	15
3.1	Functionality of the PIUR tUS Infinity .....	15
3.2	Clinical Indications.....	18
3.3	Contraindications .....	18
3.4	Clinical Benefits .....	18
4	Initial Use .....	19
4.1	Delivery Package .....	19
4.2	Equipment of the main components .....	21
4.2.1	Requirements to the Computer (laptop).....	21
4.2.2	Equipment of the Infinity Box .....	22
4.2.3	Equipment of the Infinity Sensor .....	22
4.3	Connection with the Ultrasound Device .....	24
4.3.1	Requirements for connected Ultrasound Devices .....	24
4.3.2	Compatibility.....	24
4.4	Switching on PIUR tUS software .....	24
4.5	Securing the Bracket to the probe .....	26
4.5.1	Front Clip.....	26
4.5.2	Securing the Sensor Housing on the front part of the Bracket .....	28
5	Using the PIUR tUS Software .....	29
5.1	PIUR tUS Start Screen.....	29
5.2	User Menu .....	30
5.3	Register New Patient .....	31

---



5.4	Navigating in the "Patient Browser" .....	32
5.4.1	Patient menu .....	33
5.4.2	Export .....	33
5.4.3	PACS Interface - only with PACS-license .....	34
5.5	Acquisition Mode .....	35
5.5.1	Optical and acoustic signals in the „Acquisition Mode“ .....	37
5.5.2	"Post-Acquisition" Mode .....	38
5.6	"Review" Mode .....	39
5.6.1	Display and Operating Window in the "Review" mode .....	39
5.6.2	Overview of the Functions in the "Review" mode .....	41
6	PIUR tUS Infinity: Commencing Operation and Conducting the Examination .....	52
6.1	Moving the Ultrasound Probe with PIUR tUS Infinity .....	52
6.2	Parameter settings of the Ultrasound device .....	52
7	Taking out of Operation .....	53
7.1	Switching Off and Storing the Device .....	53
7.2	Charging and Storing the Device .....	53
7.3	Disinfecting and Cleaning.....	54
7.3.1	Removing and Cleaning the PIUR Sensor .....	54
7.3.2	Removing and Cleaning the Bracket.....	54
7.3.3	Cleaning and Disinfecting of the remote control and computer .....	55
7.4	Disposing of PIUR tUS Infinity Hardware .....	56
7.5	Disposal of software and data.....	56
8	Service and Maintenance.....	57
8.1	Backup and recovery of patient data .....	57
8.2	Contact.....	57
8.3	Maintenance Interval .....	57
8.4	Software Update .....	57
8.5	Procedure in Case of Faults and Defects.....	58
9	Technical Data .....	59
9.1	General data.....	59
9.2	Technical characteristics and performance data .....	59
9.2.1	Measurement Function .....	59
9.3	Classification .....	60
9.4	Electromagnetic compatibility (EMC).....	61

# 1 General Information



## 1.1 Abbreviations and Terms

Abbreviation / term	Description
US	Ultrasound
tUS	Tomographic ultrasound

## 1.2 Symbols in User Manual

Symbol	Description
	Helpful <b>information</b> , which simplifies daily work with the device.
	<b>Attention:</b> Important information that should be understood prior to operating the device.
	<b>Safety notice.</b> Situations in which misuse can lead to personal injury or damage to property.

## 1.3 Symbols on device

Symbol	Description
	Stand-by symbol
	Wireless charging symbol

### 1.3.1 Identification Label

The identification label with the corresponding serial number can be used to identify the device. Please note down the serial number of the device before contacting the PIUR service.

#### System Label



#### Infinity Box Label

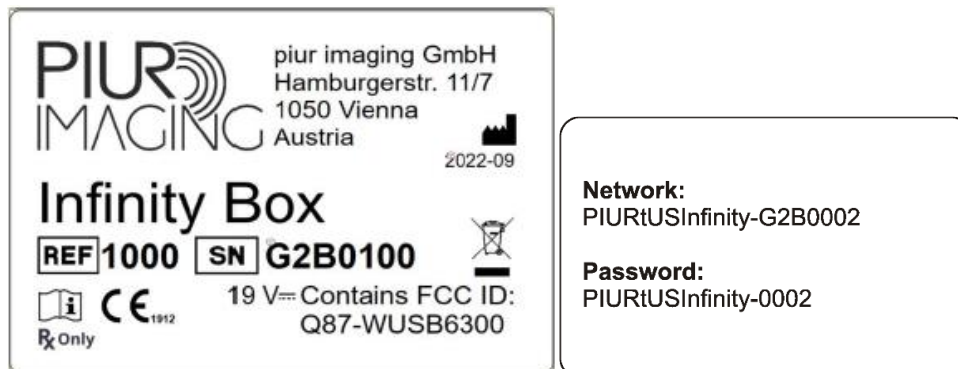

#### Infinity Box Power Supply Label

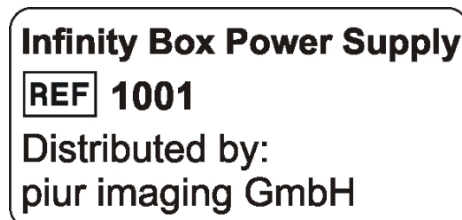

**PIUR Sensor Label**

# PIUR Sensor

UDI: (01)09120117251209(21)G3S0001

**piur imaging GmbH**  
 Hamburgerstr. 11/7  
 1050 Vienna, Austria

2021-04  
 REF 3000  
 SN G3S0001

CE 1912  
 IPX5  
 R Only  
 MD Contains FCC ID: 2AC7Z-ESPWROOM32D

Markings on device (component) and 3D model overview:

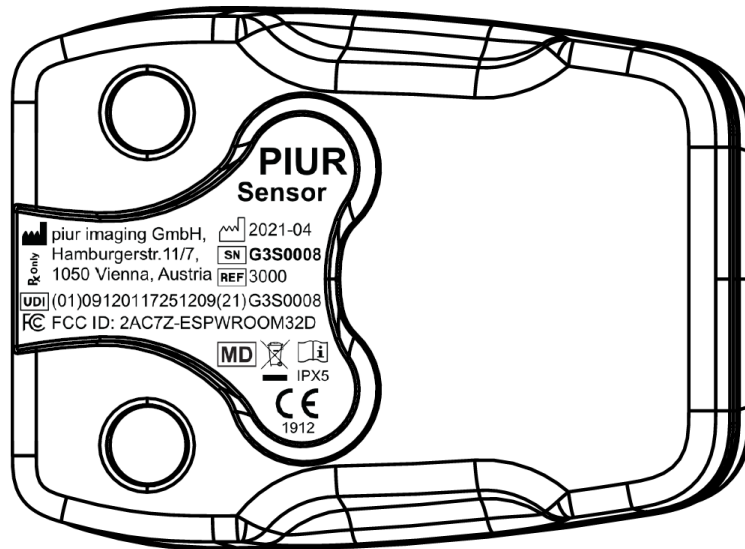

# PIUR Sensor

**piur imaging GmbH,** 2021-04  
 Hamburgerstr. 11/7, SN G3S0008  
 1050 Vienna, Austria

UDI (01)09120117251209(21)G3S0008  
 FCC ID: 2AC7Z-ESPWROOM32D

MD IPX5  
 CE 1912

**PIUR tUS Software Label**

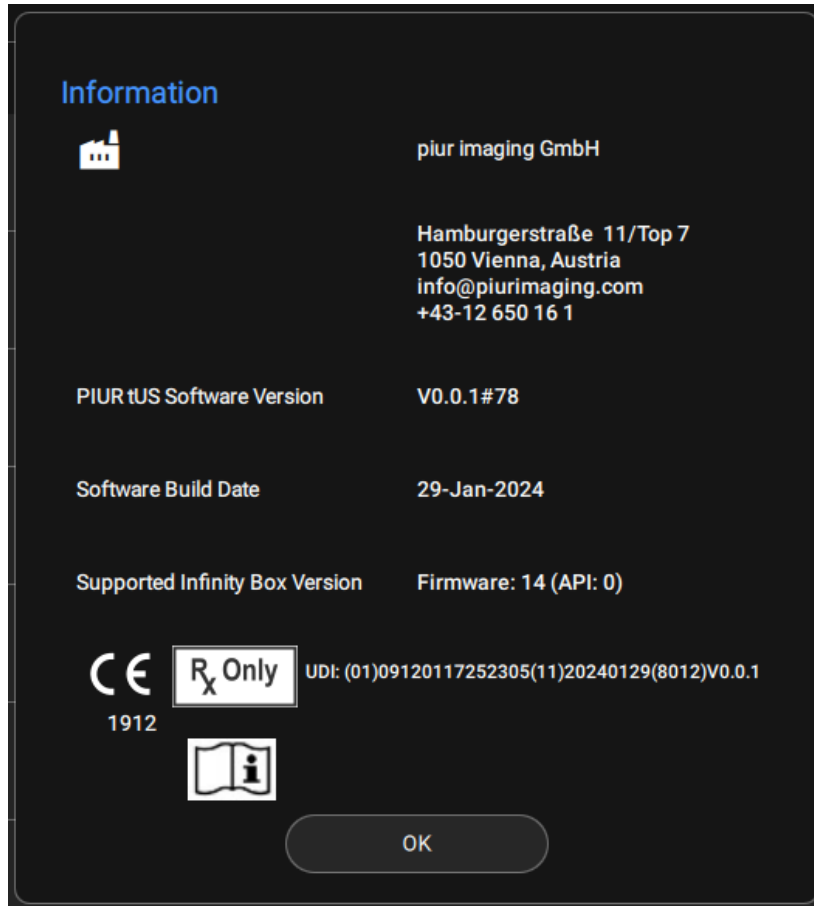





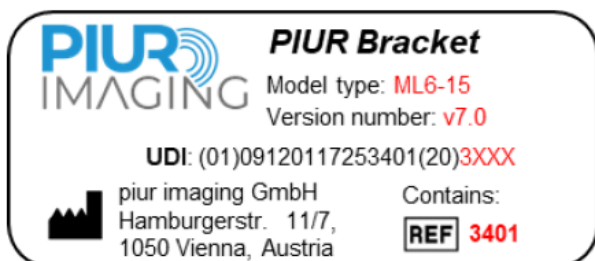



Remark: PIUR tUS Software Version will be the Software release version with respective Software Build Date.

**PIUR Bracket**





The following additional symbols can be found on the identification label:

Symbol	Description
	Serial number
	Catalogue number
UDI	UDI Carrier label, containing UDI-DI + UDI-PI parameters, displayed in HRI (human readable interpretation).
	Manufacturer
	CE mark
	Operating instructions
	Direct current
	Alternating current (AC)
	The system must not be disposed with normal waste (see chapter 7.3).
	Rx Only means that the device is a prescription device. Caution: Federal law (USA) restricts this device to sale by or on the order of a physician

## 1.4 Function of this Document

This document provides a detailed description of the PIUR tUS Infinity system and its use within the scope of the application domain it was designed for. It provides instructions for use to help the user in the safe and correct operation of the system.

---

## 1.5 Intended Use

---

The PIUR tUS Infinity system is a non-invasive, transient and active medical device which fulfills all MDR 2017/745 requirements for class IIa, intended to support the user with the examination on various clinical applications by providing 3D information generated from a sequence of external ultrasound images.

2D ultrasound images, acquired by a compatible third-party ultrasound device and position data, generated by the system integrated PIUR Sensor, are the basis for 3D image reconstruction. The third-party ultrasound device must be a medical device according to MDR 2017/745 with a valid CE-Label.

The PIUR tUS Infinity acts as part of the diagnostic chain only and must not be used as a sole source for treatment decisions.

PIUR tUS Infinity device is not intended for body contact (including skin, mucosal membrane, breached or compromised surfaces, blood path indirect, tissues, bones, dentin, or circulation blood).

---

## 1.6 Disclaimer

---

The manufacturer is not responsible for improper use, failure to comply with the safety notes and non-observation of specifications due to negligence. Piur imaging only assumes responsibility for the safety and reliability of the PIUR tUS Infinity system and components when all changes, enhancements, repairs and other work to the device and/or system have been performed by an authorized dealer of piur imaging and certified service person, or piur imaging directly and the User Manual has been observed before and during device operation.

**Safety Notice:** Do not modify this equipment without authorization of the manufacturer.

---

## 1.7 General Residual Risk including significant Risks

---

Considering possible sources of failure, foreseeable and unforeseeable errors of use and after risk mitigation residual risk of this medical product remain. Within the Risk Management process, a total of 90 residual risks have been identified. There following residual risks are considered as significant:

- Wrong image information

As a diagnostic system the most relevant output of the device is image information. This image information can influence medical decision in terms of therapy, treatment, prevention or further alternative diagnostic information. Caused by various factors the system may display incorrect image information after the image reconstruction. This wrong image information can be caused by erroneous input of image or tracking source or by software or user errors. The wrong image information can either appear as bad image quality or unrealistic image content in terms of anatomical appearance. In both cases the error is obvious to the user. In rare cases the wrong image information can display anatomically reasonable content that cannot be identified as obvious wrong image information and therefore may mislead the user and lead to undesired consequences- in the worst case not getting necessary interventions or surgery or getting unnecessary intervention and surgery. This residual risk affects the patient.

---

- Incorrect measurement

Measurement features as part of the software can influence the diagnostic decision and therefore effect further therapy, treatment, prevention or further alternative diagnostic information of the patient. Due to various sequences of internal or external event, errors of use or inadequate image input measurement errors can occur. Especially out of plane (length) measurements depend on appropriate use and adequate image input with sufficient frame rate. The residual risk is a measurement deviation outside of the disclosed error range that may lead to wrong image information as the residual risk above "Wrong image information". This residual risk affects the patient. For further details of measurement deviation and errors please see chapter 9.2.1 Measurement Function.

All residual risks are accepted and considered under the scope of the Risk Management file.

---

## 1.8 Recommendations regarding cybersecurity:

---

The user of the PIUR tUS Infinity system is responsible for securing the computer that runs the PIUR software against data loss and access by non-authorized users. The database is encrypted to reduce the risk of non-authorized access. However, it is highly recommended to run regular backups of the patient database using the backup function provided by the software to avoid loss of data. It is also recommended to restrict access to the computer using password protection. If several users have access to the computer, it is recommended to restrict access to the PIUR software for selected users, for example through drive-partition or access restrictions to the installation folder. To protect the computer against non-authorized access, it is recommended to install an anti-virus application, a firewall and the latest Windows 10 Updates on a regular basis.

---

## 1.9 Contact and Regulatory Information

---

PIUR tUS Infinity is a medical device of Class IIa in accordance with the Medical Device Regulation 2017/745, Annex VIII.

The conformity of this product according to the general safety and performance requirements of MDR 2017/745 was proved with the Conformity Assessment Procedure as per Annex IX.

The manufacturer documents that with the CE-Label.

piur imaging GmbH  
Hamburgerstr. 11 / Top 7  
1050 Vienna  
Austria



## 2 Safety Regulations

The assembly of medical electrical systems and changes during the actual service life require a check with regard to the requirements set out in EN 60601-1 clause 16. Electrical installations in the room where PIUR tUS Infinity is used shall comply with the following:

	<p>To avoid risk of electric shock, this equipment must only be connected to a supply main with protective earth</p>
	<p>Do not modify this equipment without authorization of the manufacturer.</p>
	<p>Connect only items that have been specified as part of the medical electrical system or that have been specified as being compatible with <b>the medical electrical system</b>. An additional multiple socket-outlet or extension cord must not be connected to the medical electrical system.</p>
	<p>The system is suitable for use in hospitals and professional healthcare environment except for near active HF surgical equipment and the RF shielded room for magnetic resonance imaging, where the intensity of EM disturbances is high.</p>
	<p>Use of this equipment adjacent to or stacked with other equipment should be avoided because it could result in improper operation. If such use is necessary, this equipment and the other equipment should be observed to verify that they are operating normally.</p>
	<p>Use of accessories and cables other than those specified or provided by the manufacturer of this equipment could result in increased electromagnetic emissions or decreased electromagnetic immunity of this equipment and result in improper operation.</p>
	<p>Portable RF communications equipment (including peripherals such as antenna cables and external antennas) should be used no closer than 30 cm (12 inches) to any part of the PIUR tUS Infinity System, including cables specified by the manufacturer. Otherwise, degradation of the performance of this equipment could result.</p>
	<p>If malfunctions and defects occur.</p> <p><b>Occurrence of malfunctions and defects can lead to personal injury or damage to the device.</b></p> <p>If malfunctions and defects occur, discontinue the use of the PIUR tUS system and inform our service team via the above contact details.</p>



The Sensor contains LED for skin illumination. During the acquisition, this LED should not face the eye.



Do not exchange batteries without authorization of the manufacturer



Only the in chapter 4.1 specified power supply shall be used.

## 2.1 User Requirements for Use



- The user has been officially trained by an authorized person in using PIUR tUS Infinity and is issued with a corresponding certificate.
- The training is provided by authorised service personal and follows the training protocol.
- The training includes system setup, patient management, image acquisition, image review, data export/import, typical errors of use, possible system errors and system shutdown.
- The assistants have carefully read and understood the User Manual.
- The user is required to observe the safety instructions and to adhere to the safety provisions.
- The user has to be a physician skilled in ultrasonic diagnosis.
- Users have knowledge of human anatomy.
- Users have practical experience in the use of ultrasound for medical diagnostics and the fields of applications in which they use PIUR tUS.
- Patient should not move during the image acquisition as it could possibly lead to a wrong image data.
- The acquisition should be performed with the recommended speed of 1 - 2 cm/s
- Users have sufficient knowledge of the English language.

## 3 Product Information

### 3.1 Functionality of the PIUR tUS Infinity

PIUR tUS Infinity supplements commercially available ultrasonic devices with tomographic image representation and thus allows 3D analysis of ultrasound data, comparable with CT or MRI image representation. Examining doctors can call upon both 2D as well as 3D ultrasound data to make their diagnosis, which can simplify daily work and improve diagnostic quality.

The high-resolution three-dimensional datasets are generated by an IMU (Internal Measurement Unit) sensor tracking on the ultrasonic probe during a free hand scan. The data is transmitted to a control unit via Bluetooth. The ultrasound images are continuously sent to the PIUR tUS Infinity Box via the video output of the ultrasonic device and transmitted wirelessly to the control unit via Wi-Fi. From this two information, the system then calculates the three-dimensional volume. From the video signal, all system parameters required for data generation, such as frame rate, depth, and US probe, are automatically detected, processed and transmitted to the computer via Wi-Fi.

In order to generate three-dimensional datasets PIUR tUS Infinity requires the following components (see Figure 1):

- Computer with pre-installed PIUR tUS software
- Wireless tracking sensor installed in a compact sensor box
- A volume attachment or front clip to fix the sensors on different probe models
- A compatible ultrasound device including a probe to generate sonography images.
- Infinity box connected to the ultrasonic device

The Infinity system has no applied parts according to the standard EN 60601-1. The medical electrical system consists of the parts given in chapter 4.1, the diagnostic ultrasound device and the computer. The computer is the only non-medical equipment that has to be placed outside the patient environment. The patient environment is shown in Figure 4. patient environment. The Infinity Sensor is not an applied part according to the standard EN 60601-1 but fulfils all requirements for applied parts with exception of the marking.



Figure 1: PIUR tUS Infinity system set-up

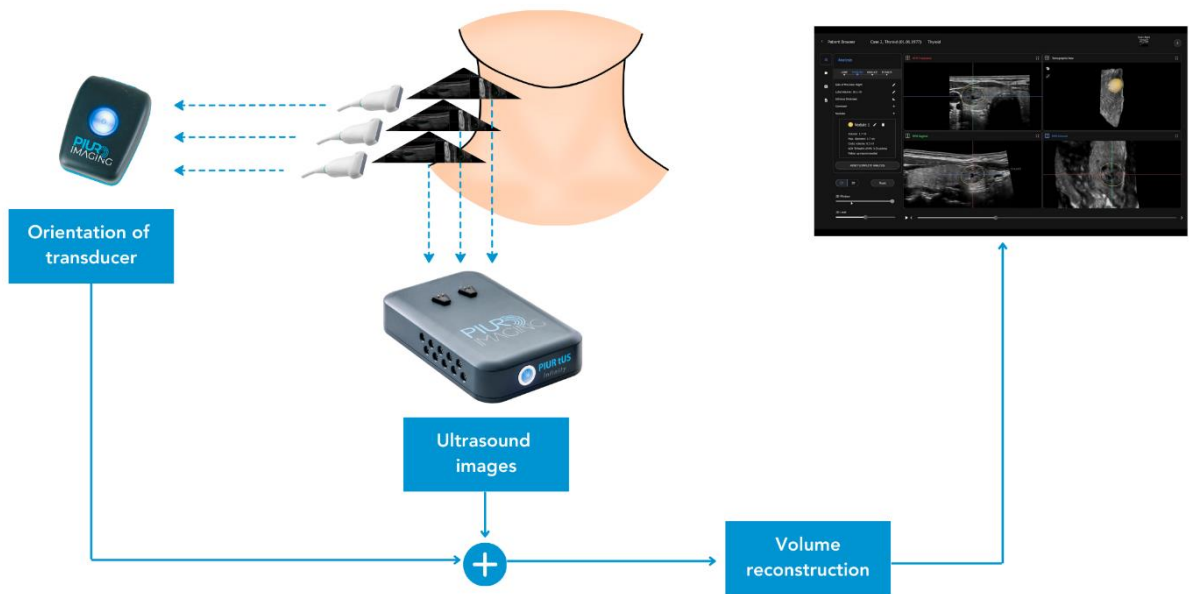

Figure 2: Generation of a 3D dataset

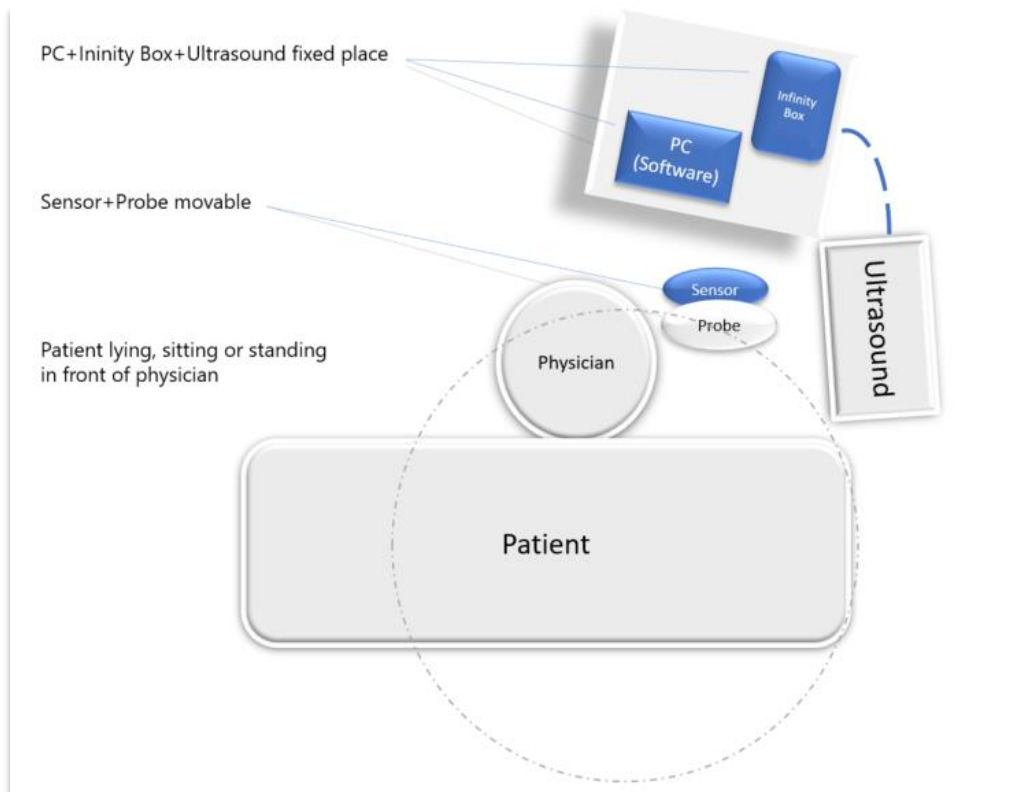

Figure 3: Clinical Setup



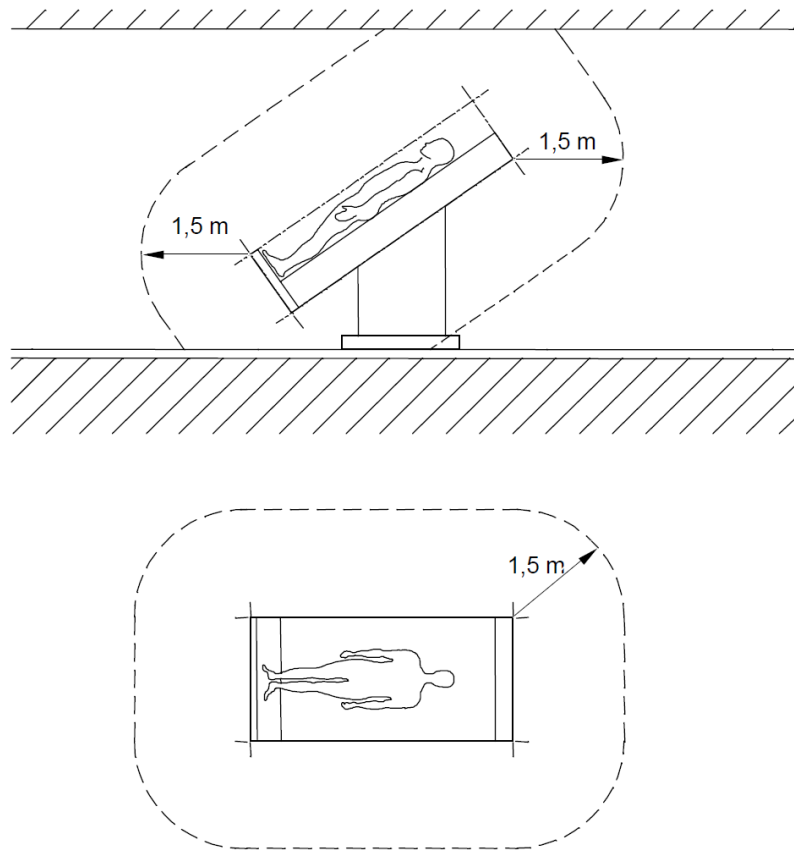

Figure 4: Patient environment as defined in EN 60601-1

## 3.2 Clinical Indications

- 1. Cerebro-vascular
- 2. Peripheral vascular
- 3. Thyroid
- 4. Peripheral neuronal
- 5. Abdominal

## 3.3 Contraindications

The PIUR tUS Infinity system must not be used under the following conditions:

- On patients with open wounds or irritated skin
- During surgery

## 3.4 Clinical Benefits

There are many patient and system benefits relating to the use of tomographic ultrasound system.

The manifold benefits often depend on the indication (see Table 1). These include:

- Reduced exposure to ionising radiation (due to reduction of required CTA acquisitions);
- Reduce exposure to nephrotoxic contrast agents (due to reduction of required CTA/MRA acquisitions);
- Reduce waiting times (due to reduction of referrals to radiology for 3D imaging; 3D imaging can be performed in ultrasound lab with PIUR tUS Infinity);
- Reduced costs (due to reduction of required CTA / MRA acquisitions and radiologist reporting);
- Shorter hospital stays (due the reduction of side effects resulting from nephrotoxic contrast used by MRA);
- Freeing resources from CT / MR scanners
- Shorter scan times (tUS scans are significantly quicker than 2D ultrasound) leading to increased departmental capacity.
- No maximal number of repeated exposure times, during the whole duration of product use.

Another great advantage of tomographic ultrasound with the aid of the PIUR tUS Infinity system is the communication between different treating physicians. Especially in the indication of arteriovenous fistulas, the doctor usually examines the artery with 2D ultrasound, but cannot provide the surgeon with an exact indication of position and shape. By storing three-dimensional images with which a localization can be easily determined, the patient can, for example, bring the data carrier to the assigned physician, as has long been standard in CT and MRI.

Application	Value Proposition				
<b>Thyroid imaging and Volume Segmentation</b>	Complete documentation and archiving in PACS	Accurate and fast measurement of thyroid lobe and nodules	Separation of scanning and image analysis, increasing patient through-put	Enabling computer-aided diagnostic workflows	

Table 1: Indication

## 4 Initial Use

### 4.1 Delivery Package



PIUR tUS Software  
(installed)



PIUR tUS Infinity Quick Guide



PIUR Bracket  
(depending on ultrasound system)



PIUR Sensor  
REF 3000



Video cable HDMI-HDMI  
REF 2130  
(max. length 2 m)



Infinity Box  
REF 1000  
(HDMI input for video cable to connect  
with ultrasonic device)



Video adapter HDMI-DVI  
REF 2133



Video adapter HDMI-Displayport  
REF 2134



Infinity Box power supply cable  
H05VV-F 3G0.75 C13 (max. length 3 m)



Infinity Box power supply  
REF 1001



LOGITECH Remote control  
REF 2140

Remote control to start and stop image acquisition  
on PIUR tUS device



Anker Wireless charger  
REF 3300



Suitable cables for the mains plug of the respective countries are supplied by the manufacturer and can be reordered if necessary.

---

## 4.2 Equipment of the main components

---

### 4.2.1 Requirements to the Computer (laptop)

The PIUR tUS Infinity software is designed to run on a common computer (laptop) and all platforms basically that meets the following requirements:

**Minimum requirements:**

Windows operating system

Windows 10 64-bit operating system, version 1803 or higher

Windows 11 64-bit operating system

Full HD Display (1920x1080 pixels)

NVIDIA Graphics Card with at least 4GB GPU memory (e.g. NVIDIA GeForce GTX1050 or similar)

**Important:** Must be NVIDIA 10<sup>th</sup> series or newer (e.g. GTX10XX, RTX20XX, RTX30XX, RTX40XX) or equivalent NVIDIA workstation card

Quad-core processor (e.g. Intel i5 or AMD Ryzen 5)

8GB RAM or more

Bluetooth 4.0 or higher (supporting Bluetooth Low Energy)

Wireless LAN (5 GHz Wi-Fi, supporting 802.11n standard)

256 GB SDD

**Recommended requirements:**

Windows operating system

Windows 10 64-bit operating system, version 1803 or higher

Windows 11 64-bit operating system

Full HD Display (1920x1080 pixels)

NVIDIA Graphics Card with 8GB GPU memory (e.g. NVIDIA GeForce GTX 3050)

**Important:** Must be NVIDIA 10<sup>th</sup> series or newer (e.g. GTX10XX, RTX20XX, RTX30XX, RTX40XX) or equivalent NVIDIA workstation card

Hexa-core processor (e.g. Intel i7 or AMD Ryzen 7)

16GB RAM or more

Bluetooth 4.0 or higher (supporting Bluetooth Low Energy)

Wireless LAN (5 GHz Wi-Fi, supporting 802.11n standard)

1 TB SSD

## 4.2.2 Equipment of the Infinity Box

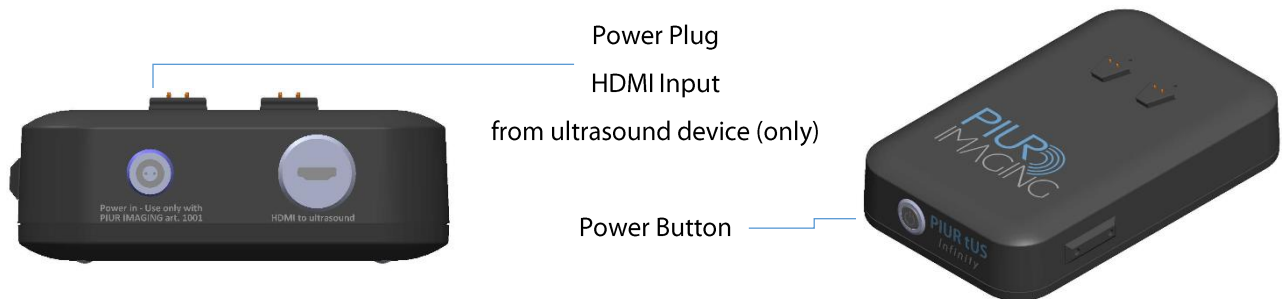

The video streaming box has an integrated frame grabber that continuously sends video signals to the computer. The box is automatically connected to your computer by internal Wi-Fi, make sure the Wi-Fi connection is active and you are in the same room.

In addition, the video box must be connected to the current ultrasonic device with a video cable and on the other hand to the computer system via Wi-Fi. The box can be attached to the ultrasonic device by the included mount.

## 4.2.3 Equipment of the Infinity Sensor

### Properties

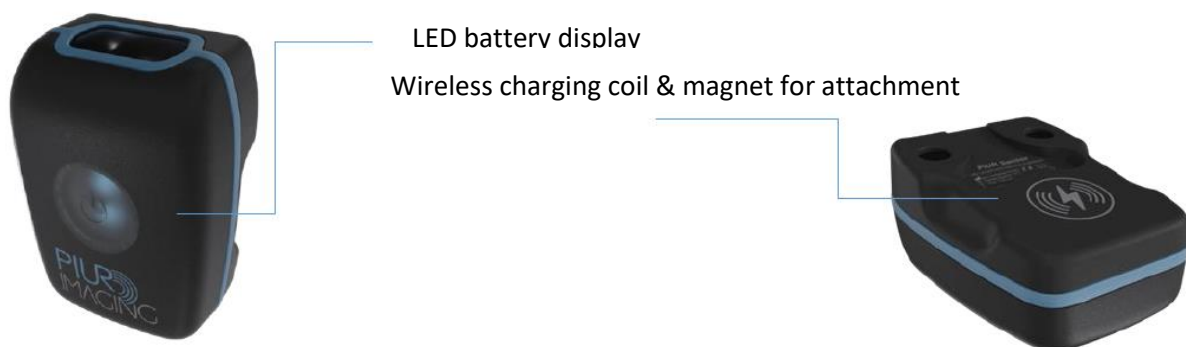

The PIUR Sensor provides information about movement of an ultrasound transducer. It is embedded in a protective housing, which is fixed to the ultrasound transducer through an attachment. The PIUR Sensor can be charged using the provided wireless charger. The Sensor connects to other devices through a Bluetooth interface.



#### Information:

LED display provides information about the system status

**The Infinity Sensor falls into sleep-mode if battery status is lower than 10% or if sensor has been disconnected for 10 minutes.**

→ Sensor can be re-started manually by pressing the start-button



The PIUR Sensor should be charged immediately after it shows battery status low and before the Infinity Sensor is not in use for a longer period.



Do not connect other Bluetooth devices as headsets or phones with the computer while using the Infinity Sensor



The damage of the sensor window from sharp tools or strong mechanical forces can result in harm to the internal electronics, consequently, lead to the non-usable system

Status	Colour	Position
Sensor is charging	blinking green	On the charging Dock
Sensor fully charged =100%	static green	On the charging Dock
Sensor after turned on & searching for connection (Sensor <15%)	blinking yellow	During use
Sensor after successful connection (Sensor <15%)	static yellow	During use
Sensor after turned on & searching for connection (Sensor >=15%)	blinking blue	During use
Sensor after successful connection (Sensor >=15%)	static blue	During use
Sensor lost connection	blinking blue	During use
Sensor has error	blinking yellow	During use
Sensor startup	static white	During use

---

### 4.3 Connection with the Ultrasound Device

---

The computer on which the PIUR tUS software is used is connected to the Infinity Box via Wi-Fi. The Video Box connects to the ultrasound device through a video cable. Two cables suitable for the respective ultrasonic device (DVI and HDMI) are included. The Infinity Sensor provides the information of the Video Box to the computer, which processes the information using the software.

1. Connect the video cable to the ultrasound at the intended video output and connect it to the Infinity Box (HDMI)
2. Turn on the Video Box with the power button and then make sure the Box is connected to the computer via Wi-Fi

**Network:** PIURtUSInfinity-\*SerialNumber\*

**Password:** PIURtUSInfinity-\*last 4 numbers of serialnumber\*



Exclusively ultrasound device(s) integrated by PIUR must be used. The use of an ultrasonic device of different type or manufacturer is prohibited.

#### 4.3.1 Requirements for connected Ultrasound Devices

- The US Device has an HDMI, DisplayPort, or DVI video output
- The US Device has a minimum screen resolution of 1280 x 720 pixels

#### 4.3.2 Compatibility

The list of compatible ultrasound devices can be obtained from the manufacturer. Please contact **service@piurimaging.com**

---

### 4.4 Switching on PIUR tUS software

---

1. Make sure the video cable is plugged between the Infinity Box and the ultrasonic device
2. Make sure that the ultrasonic device and computer are switched on and that the respective components are connected to each other
3. Turn on Infinity Box pressing the button



4. Open the PIUR tUS software by double clicking on the icon



It is recommended to close all other running applications before using PIUR tUS software to optimize performance.

The software checks the required resources, when it is starting to make sure enough memory is available.



Make sure there is a connection to all components. If one of the devices is not connected, no image will be transferred to your computer.



The device is properly installed and can operate safely and correctly if the following criteria are met:

- Infinity Sensor Illumination is blue
- Software is started
- Infinity Box is connected to the Wi-Fi and the Ultrasound system



The connection to the supply system can be separated by pulling the power plug or device plug. Make sure that the system is placed in a way that the power outlet or the device plug can be reached easily.

---

## 4.5 Securing the Bracket to the probe

---

### 4.5.1 Front Clip



1. Turn the probe as shown in the picture



2. Hook the PIUR Bracket to the right side of the probe and pull the clip on the Bracket plate over the sensor head until it locks into place with a click. Ensure the correct orientation of the probe.



3. The front clip must be correctly locked in and secure.



**Information:** Follow the User Manual in the reverse order to disassemble the clip.



**Safety Notice:** Use of not certified Attachments

- Only officially attachments delivered by piur imaging GmbH are allowed to use with the device.

#### 4.5.2 Securing the Sensor Housing on the front part of the Bracket



1. Place the sensors on the Bracket docking plate. The sensor should be attracted easily by the docking plate.



2. Make sure the sensor is snapped in properly before continuing with the acquisition workflow.



**Information:** Follow the User Manual in the reverse order to disassemble the attachment.

## 5 Using the PIUR tUS Software

### 5.1 PIUR tUS Start Screen

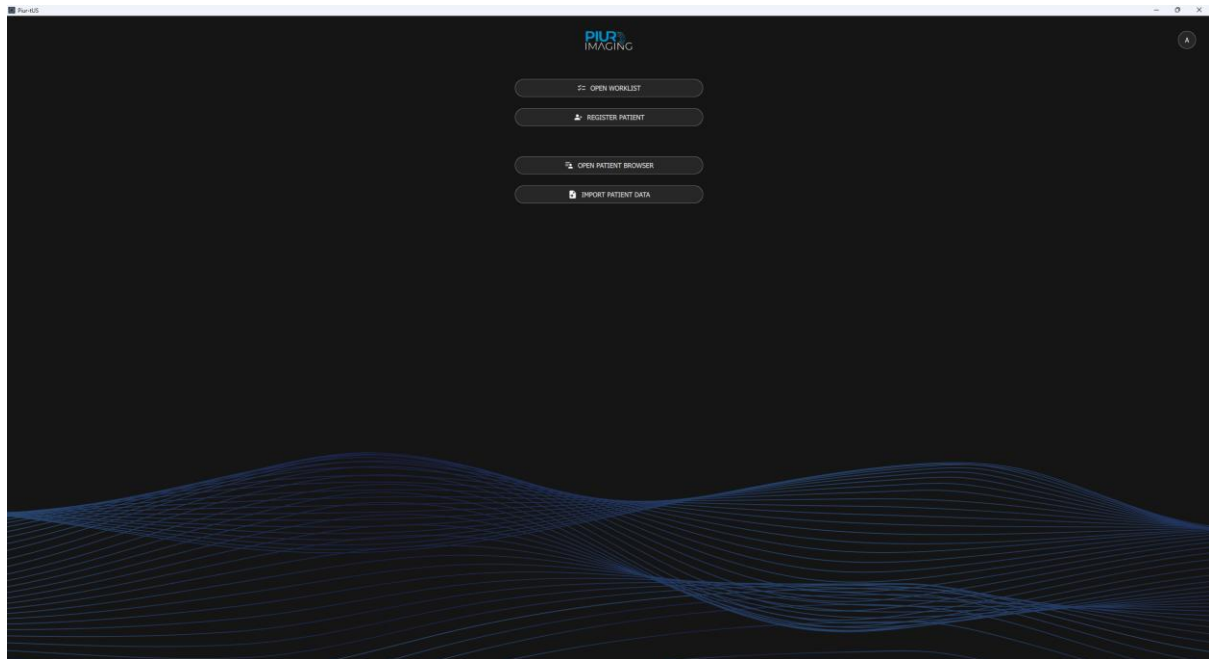

Figure 5: PIUR tUS starting screen

Explanation of the symbols and functions:

**“Open Patient Browser”**

Opens the patient database in which the files from the already entered patients are located.

**“Open Worklist”**

Opens the worklist interface, to insert the patient information provided by the worklist server.

**“Register Patient”**

Opens a window for register a new patient.

**“Import Patient Data”**

Opens an explorer window for importing patient data.

## 5.2 User Menu

Click on the User Icon in the top right corner

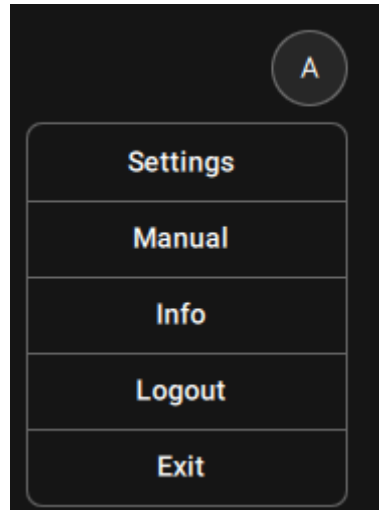
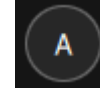

Figure 6: User Menu

Explanation of the symbols and functions:

<b>"Settings"</b>	Opens the settings where "User Settings", "General", "Infinity Box & Sensor", "PACS & Worklist" and "Licensing & Integration" can be modified.
<b>"Manual"</b> <b>„Training Videos“</b>	Opens the digital user manual. Opens a window with link and a QR code forwarding to Training Videos on the piur imaging website.
<b>"Info"</b>	Opens a window with current information about piur imaging GmbH, Software version, build date, supported Infinity Box Version, UDI and certificates.
<b>"Logout"</b>	Logs out the User.
<b>"Exit"</b>	Closes the application.

## 5.3 Register New Patient

a) Click on "Register Patient"

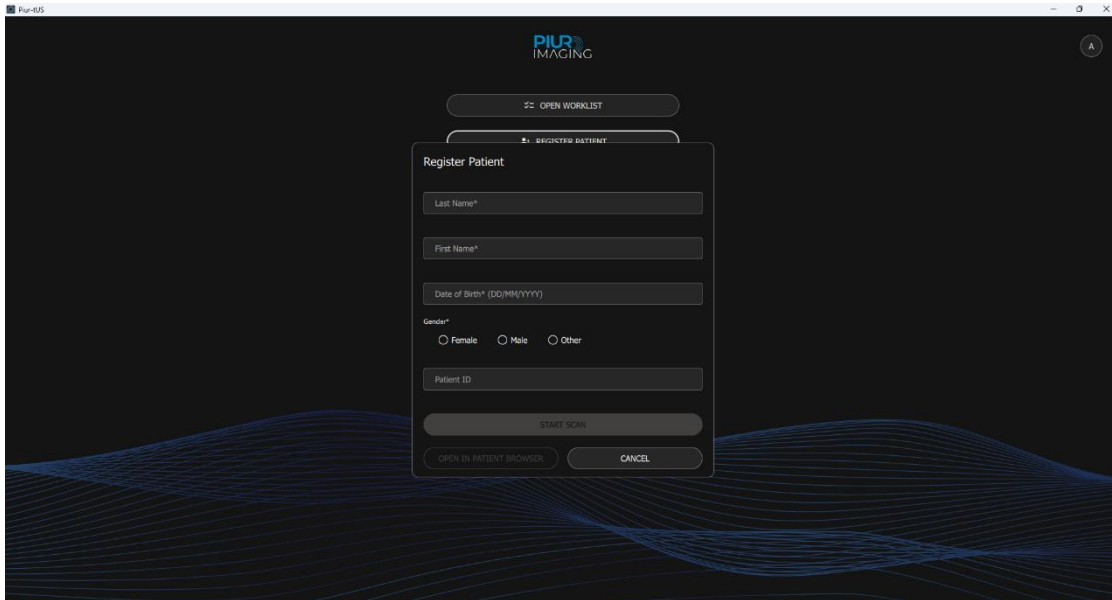

Figure 7: User interface "Register Patient"

- b) Enter all the required data in the fields provided. Entries are mandatory for fields marked with \*.  
 c) Confirm the entries with the button „Start Scan“ or “Open in Patient Browser”.

<b>“Cancel”</b>	Cancels the process, no new patient will be registered in the database.
<b>“Start Scan”</b>	Registers the patient after filling all fields and switches to "Acquisition-mode".
<b>“Open in Patient Browser”</b>	Saves the new patient and automatically opens the patient browser

## 5.4 Navigating in the "Patient Browser"

In the start screen, click on "Open Patient browser"

A list of the patients previously entered is displayed in the "Patient Browser". By clicking on a patient, a further list opens with the scans previously taken for the selected patient. The free text search function and the sorting functions "Last name" / "First name" / "Patient ID" / "Birth Date" / "Last used" / "Last study" / "Birth Date" / "Status" can be used for a simplified patient search. Scans, Screenshots and reports are shown below the belonging study.

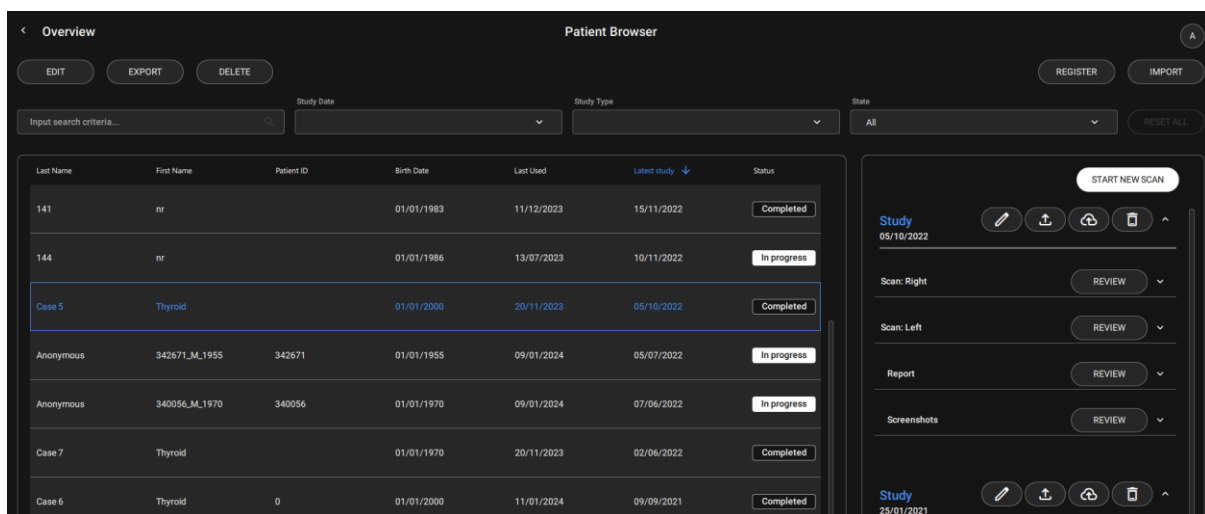

Figure 8: User interface "Patient Browser"

### "Edit"

Opens patient registration window. All the patient information here can be edited and updated.

### "Export"

Opens the "Export" window for DICOM and PIUR Export. Single items from the patient can be selected.

### "Delete"

Deletes the selected patient (incl. scans, screenshots, report) after confirmation.

### "Register"

Opens "register" new patient window in the database.

### "Import"

Opens the file explorer to import patient datasets from an external source (external hard disk or USB stick)



**Information:** Use the "Export" function to regularly back-up patient data on an external medium.



### 5.4.1 Patient menu

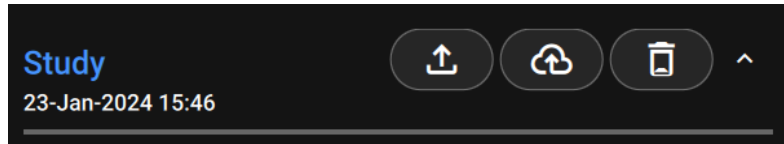

Figure 9: Options menu for editing or deleting a scan

Study name

Double click to change the name of the study



Opens the "Export" window for DICOM and PIUR Export



Opens the „Send to PACS" window.



Deletes the selected patient or scan / screenshot / report after confirmation.

#### **"Start new scan"**

Switches to the acquisition mode to start a new scan for the selected patient. (Figure 8)

#### **Scan "Review"**

Opens the review screen with the acquired diagnoses and the possibility to start or redo the analysis (Figure 8)

#### **Report "Review"**

Opens report in Fullscreen. (Figure 8)

#### **Screenshots "Review"**

Opens screenshots in Fullscreen. (Figure 8)

### 5.4.2 Export

Studies can be exported either as DICOM or PIUR file. Click on the folder symbol  to select the desired file path to store the entire study. Optionally, all files, image data (without labels) or just screenshots can be exported. In addition, by clicking on "Anonymize data" anonymized data can be exported for study purposes (Figure 10).

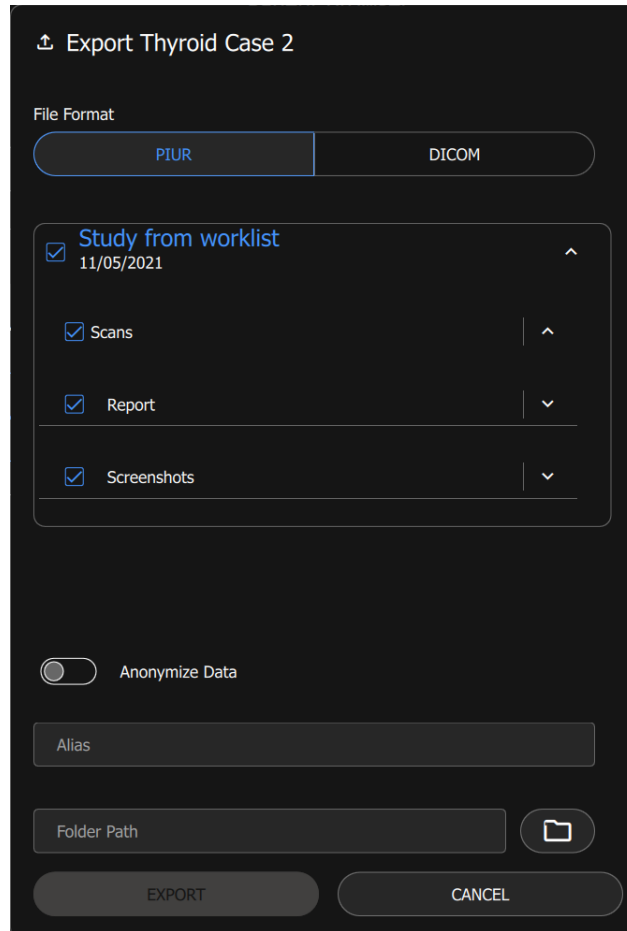

Figure 10: Export Study as DICOM or PIUR file

### 5.4.3 PACS Interface - only with PACS-license

The PACS is a digital system for processing, managing and archiving medical images and data. Image data of the modalities are sent to a central PACS server, stored there and in turn made available in diagnostic, viewing and post-processing locations. The merging of the individual modality takes place via DICOM format. Data can be send to PACS from Patient Browser.

## 5.5 Acquisition Mode

After entering a new patient and selecting the function „start new scan“ in the Patient Browser, the PIUR tUS system automatically switches to the Acquisition mode.

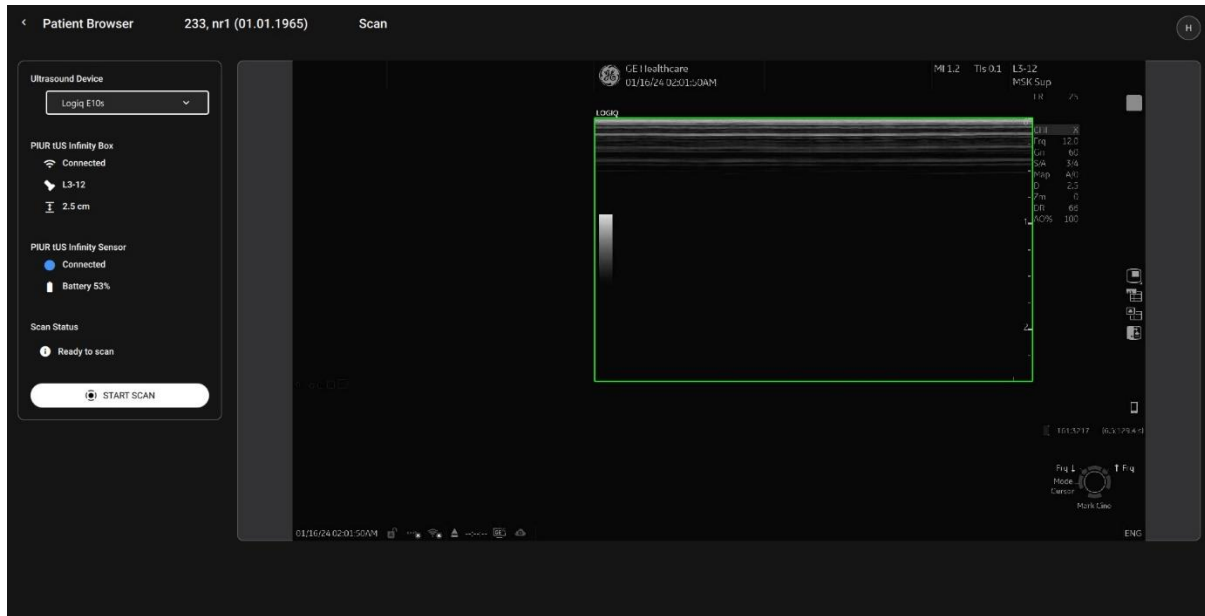

Figure 11: Acquisition mode

### „Ultrasound Device“

If there is more than one ultrasound device configured with the PIUR tUS system, the ultrasound device currently connected must be manually selected. If only one ultrasound device has been configured, this is automatically selected by the system.

### „PIUR tUS Infinity Box“

Shows the status of the box connection. If there is no box connection, the user is informed to turn on the Wifi on the PC in order to connect to the PIUR tUS Infinity Box. If the Box is connected and the correct US device configuration is selected, the transducer in use and the correct depth is displayed.

### „PIUR tUS Infinity Sensor“

Shows the status of the Sensor connection. If there is no connection, the user gets informed to turn on or charge the Sensor. If the Sensor is connected, it says "Connected" with a blue point. Below the battery level of the Sensor is displayed.

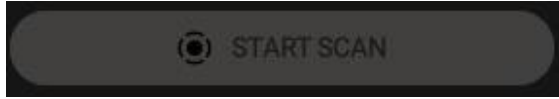

If the Scan Status is "not ready to scan", the "Start" button is greyed out. The acquisition cannot be started.



If the Scan Status is "ready to scan" the "Start" button is active. An acquisition can be started. After starting, a "Stop" button is displayed in place of the "Start" button. Begin the probe movement after you heard the audio feedback. After acquisition, the system switches to the "Post-Acquisition Mode" user interface.



**Information:** It is possible to start and stop the scan with the optionally delivered remote control. The scan can be initiated and stopped by pressing the "right arrow" key of the remote control.

**Important:** Use of the delivered remote control may only be performed by the treating doctor/staff but **not** by the patient.



**Safety Notice:** Erroneous detection of parameters. In rare cases a system parameter can be

wrongly identified. The Auto-detection symbol still lights green in this case.

- To avoid errors in the dataset, the parameters recognised by Auto-detection have to be checked visually before **every** acquisition.

### 5.5.1 Optical and acoustic signals in the „Acquisition Mode“

A series of optical and acoustic warning signals in the acquisition mode show application errors during the recording to ensure ideal handling and an optimal recording quality. The following table provides information on occurring warning signals:

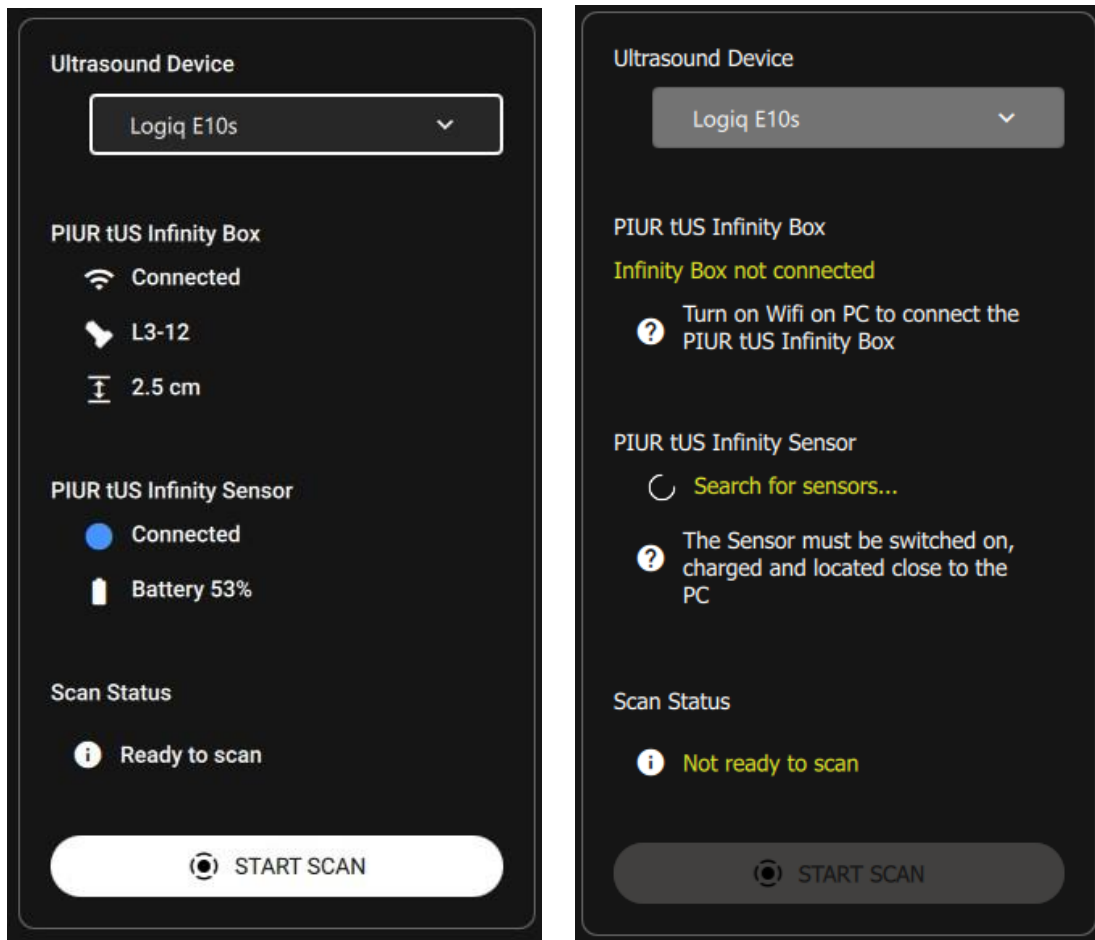

Start/Stop beep	Starting and stopping an acquisition emits a significant two-tone beep.
Warning beep	Occurs if sensor and/or box are not connected , or wrong US device selected.



**Information:** Make sure the sound of the computer is turned on and the volume is high enough to hear all warning signals clearly.

## 5.5.2 "Post-Acquisition" Mode

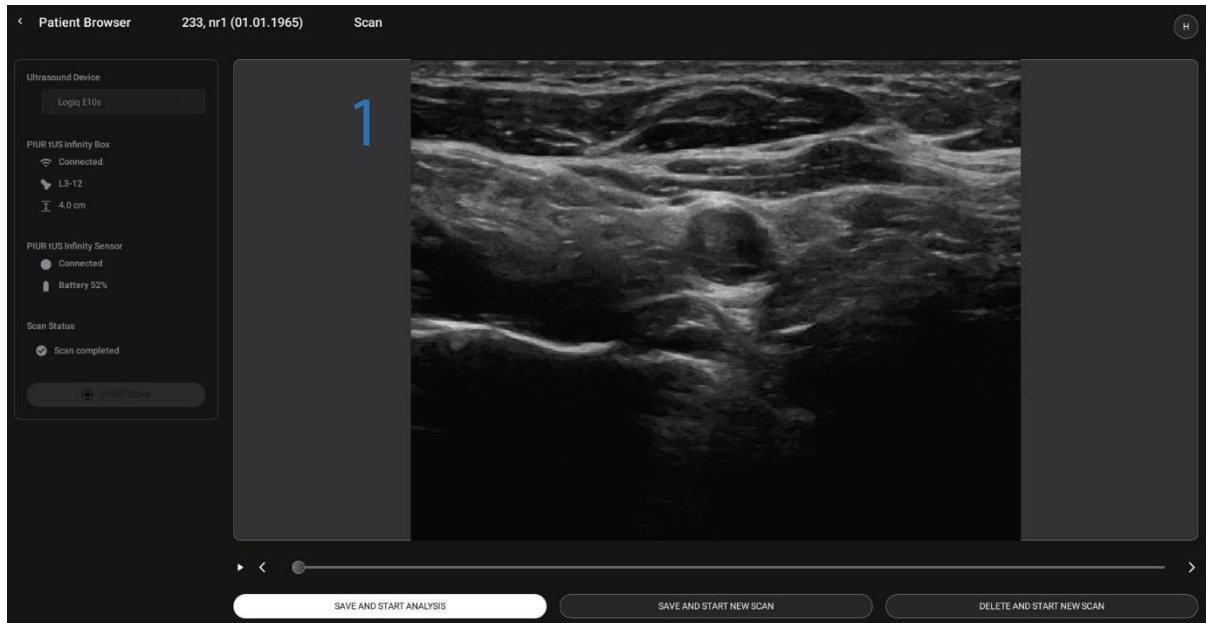

Figure 12: "Post Acquisition" user interface with Single Sweep License

1

„On-the-fly“ transversal image display of the acquisition. The MPR slider can be used to scroll through the transversal planes of the acquisition.

**„Save and start analysis“**

Saves the acquisition and then switches to "Analysis" mode. (5.6.2.4)

**„Save and start new scan“**

Saves the acquisition and then switches back to the "Acquisition" mode to create a further scan.

**„Delete and start new scan“**

Deletes the acquisition and then switches back to the "Acquisition" mode to create a further scan.

## 5.6 "Review" Mode

### 5.6.1 Display and Operating Window in the "Review" mode

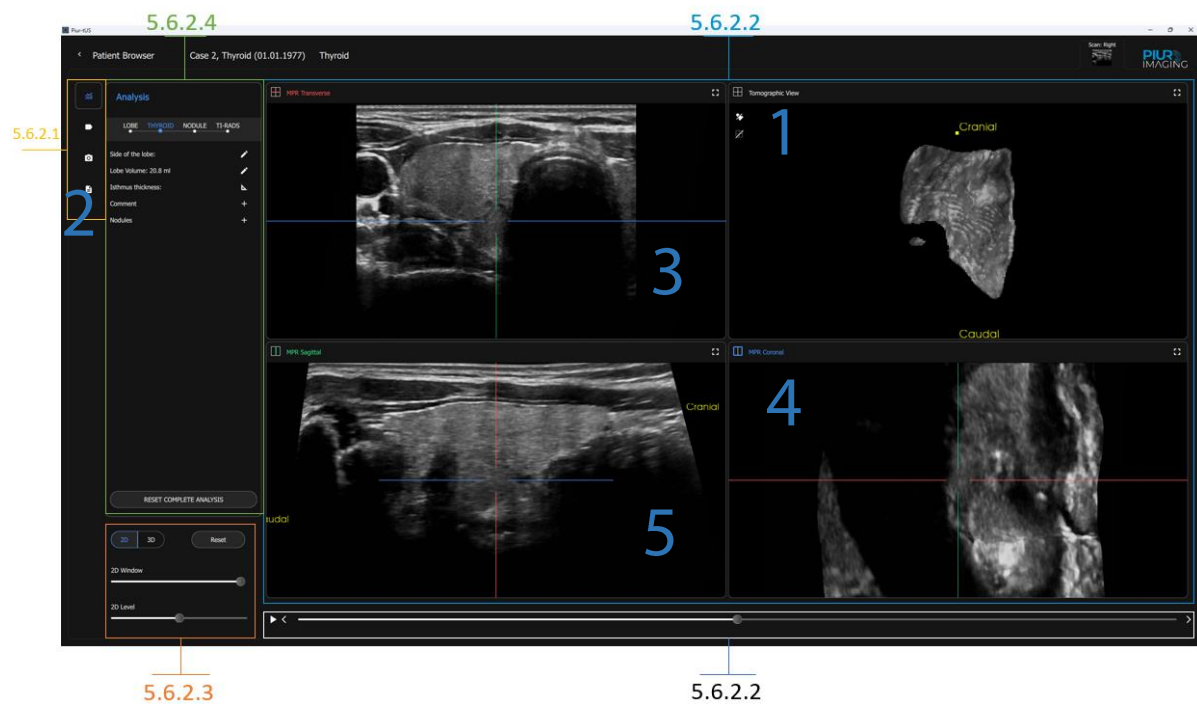

Figure 13: Operating window in the "Review" mode

1

3D reconstruction: Represents the reconstructed ultrasound volume as a 3D reconstruction. Keep the left mouse button pressed to rotate the volume. The volume can be shifted with the right mouse button or middle mouse button pressed. The zoom factor can be set with the mouse wheel. The sectional planes (3, 4, 5) are represented in the 3D reconstruction as a box, which can be hidden and shown in the toolbar (see 5.6.2.2 )

2

Tool Selection: Provides different tools for analysis, annotations, taking screenshots and reports

3

Multiplanar reconstructions (MPR) of the transversal plane: Transversal section through the volume. With a left-click on the inner parts of the plane lines, both lines can be moved (green = sagittal and blue = coronal plane). Left-click on the outer parts of the plane line the respective plane can be rotated.

4

Multiplanar reconstructions (MPR) of the coronal plane: Frontal section through the volume. With a left-click on the inner parts of the plane lines, both lines can be moved (green = sagittal and red = transversal plane). Left-click on the outer parts of the plane line the respective plane can be rotated.

5

Multiplanar reconstructions (MPR) of the sagittal plane: Sagittal section through the volume. With a left-click on the inner parts of the plane lines, both lines can be moved (red = transversal and blue = coronal plane). Left-click on the outer parts of the plane line the respective plane can be rotated.

#### Relevant for all 2D view windows:

Left click in the inner part of MPR-line	Moves both plane lines. Focus remains on same spot in image.
Left click in the outer part of MPR-line	Rotates the respective plane line. Focus remains on the same spot in image.
Left double click (in one 2D view)	Places the intersection point of the two planes at the point.
Left click hold and move up and down anywhere (in one 2D view) or scrolling the mouse wheel	Scrolling through the slices of the respective 2D view.
Right click hold and move up and down anywhere (in one 2D view)	Zooming in all three 2D views.
SHIFT + left click anywhere (in one 2D view):	Moves the image.
STRG + hold left click and move up and down anywhere (in one 2D view)	Up: increases window level Down: decreases window level
STRG + hold left click and move left and right anywhere (in one 2D view)	Right: increase level value Left: decrease level value
STRG + hold left click and move up/down and left/right at once	Combination of window and level value in-/decrease



## 5.6.2 Overview of the Functions in the "Review" mode

### 5.6.2.1 Tool Selection



Analyse Lobe and Nodules à see chapter 5.6.2.5



Annotations + Measurements à see chapter 5.6.2.5



Able to create 2D and 3D Screenshots



See and update report



„Exit“ patient. Jump back to Patient Browser.

If automatic report generation and/ or auto-send to PACs is turned on: Pressing button provokes the sending of all new changes in the review screen, since the last sending.

If no auto send/ saved is turned on, this button just functions as a backward button to the Patient Browser.

### 5.6.2.2 MPR view

The 2D and 3D view is controlled by (Hover symbol):

Icon	Function	Description
	Zoom	3D: zooms in and out 2D: zooms in and out in all 2D views
	Rotate	Rotates the MPR lines
	Move	Moves the MPR lines

The 3D View tools:

Icon	Function
	3D model of used transducer is visible in the 3D view.
	3D model of used transducer is <b>not</b> visible in the 3D view.
	MPR planes are visible in the 3D view.

 MPR planes are **not** visible in the 3D view.

MPR slider:



The slider moves along the orientation of the Transversal MPR plane. The bar can be moved with the slider. Or a playback can be started/paused with the button. The left and right arrows can be also used for moving individual slices.

### 5.6.2.3 Window level settings

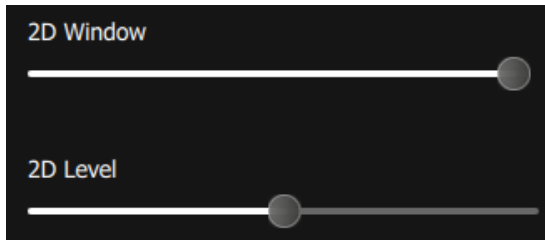

The brightness and contrast can be changed by the slider. Switches to 3D when selected

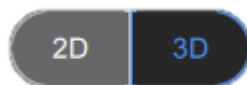

Choose between 2D and 3D, to apply on the 2D MPR or 3D view.

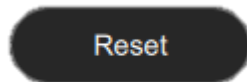

Reset the orientation of the MPR and 3D to default.

Reset the brightness of the image for 2D and 3D.

### 5.6.2.4 Analysis

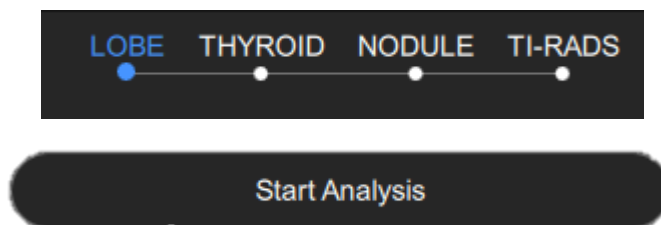

Menu Wizard

Press "Start Analysis" to trigger the prediction of the AI Network.

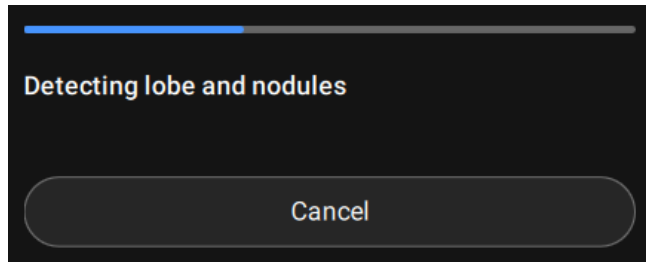

The progress bar gives indication regarding the process. There is also the option to cancel.



Auto side selection. Side can be changed by clicking respective side button.



The automatic lobe volume is displayed. There are now the options of "correction tool", "cut tool", "manual measurement tool"

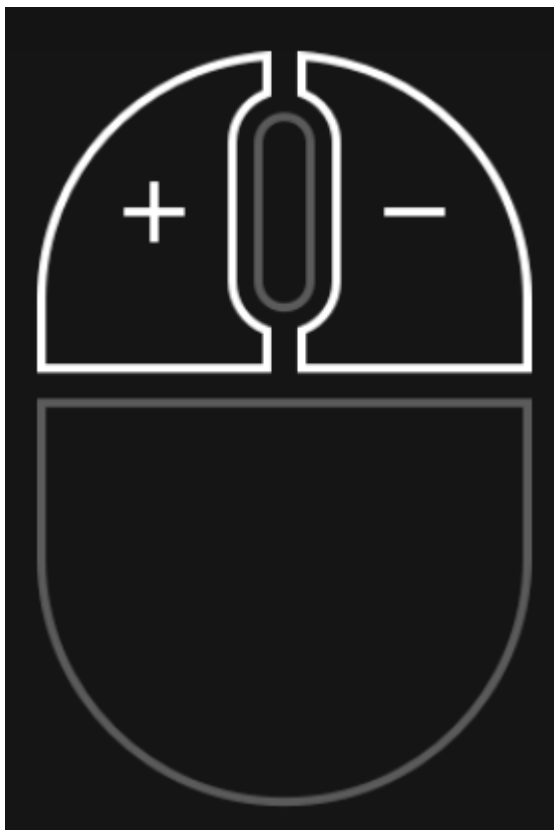

Manual lobe segmentation correction tool.

Here the user can adapt the automatic segmentation manually, by clicking the left and right mouse button as marked in the image.

"-" click and hold this button while moving over the parts of the segmentation which should be excluded from the volume segmentation

"+" click and hold this button while moving over the parts of the segmentation which should be included into the volume segmentation



Press the scissor icon, to cut parts of the lobe volume.

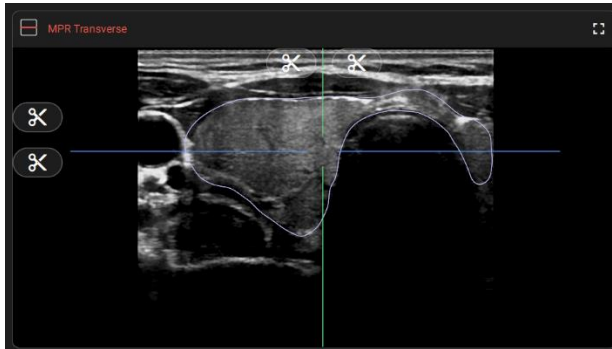

Cutting icons are displayed along the planes.

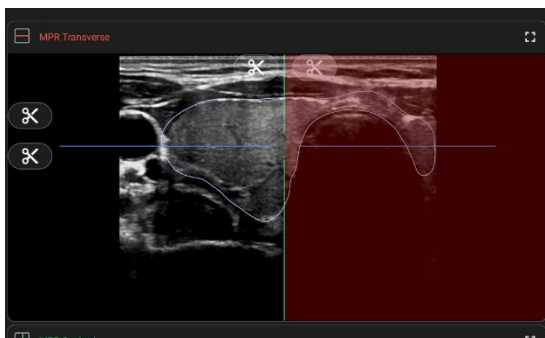

Hover with the mouse over the icon gives a preview of the to cut area.

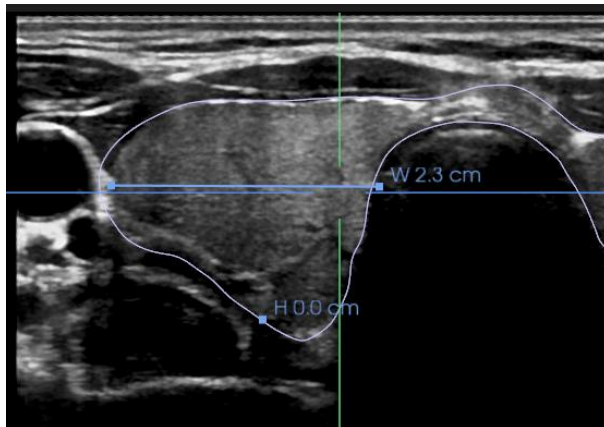

3-line manual measurement tool (Width, Height and Length).

Place the start and end point of each line by clicking in the 2D view. During the measurement, the respective letter is displayed next to the cursor.

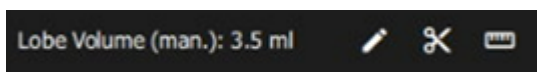

Lobe volume is adapted to the manually measured volume.

„Undo“

Jumps one step back, which was performed in the respective tool.

„Reset“

Resets all steps, which were performed in the respective tool.

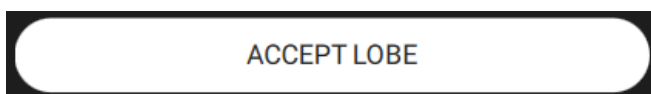

Accepts and saves the lobe including all editing steps to proceed with the analysis.

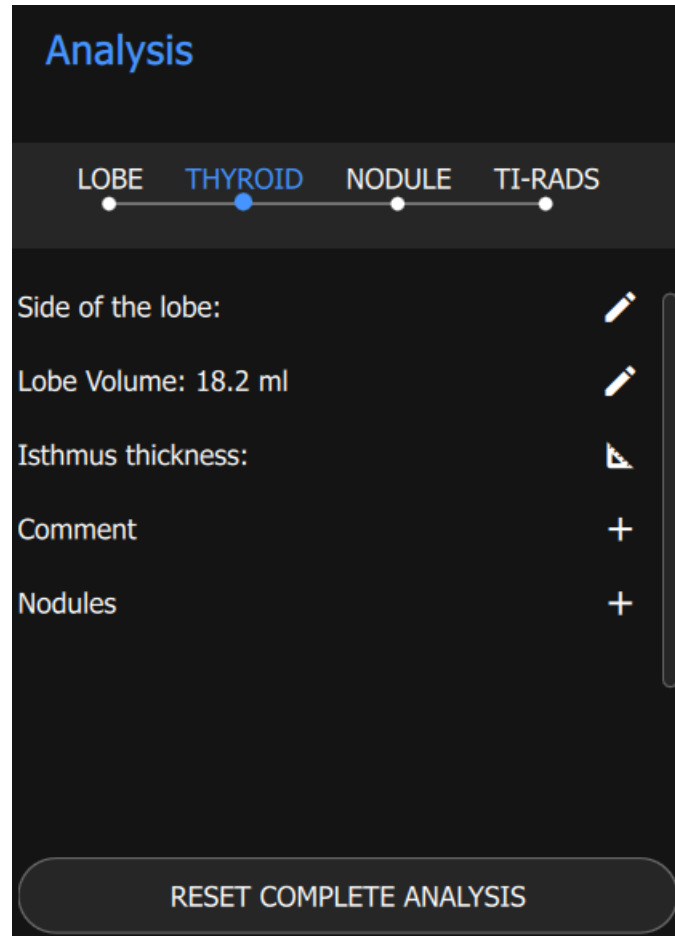

Figure 14: Analysis menu



Modify Side/ Volume of the lobe



Create a 2-point line measurement in the MPR to measure the Isthmus thickness.



Create a comment by clicking on the plus symbol. Text box opens to add text. Save the comment or discard to return to the previous menu.



The symbol implies an existing comment. The comment can be edited by clicking on the comment symbol.



Add a nodule to the analysis by clicking on the plus.

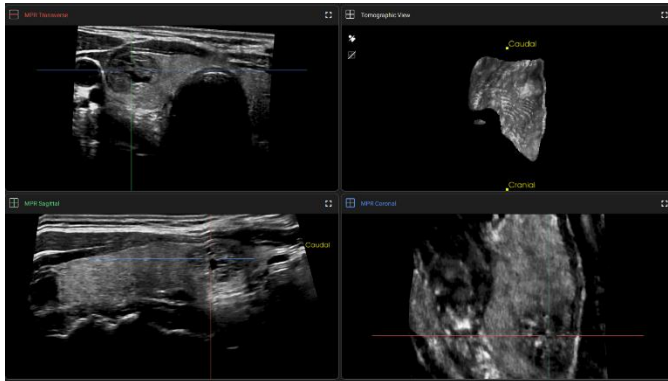

Move the MPRs to the centre of the targeted nodule.

Click in the middle. The detected nodule is shown in the MPR and 3D view.

This leads automatically to the manual nodule segmentation correction tool.

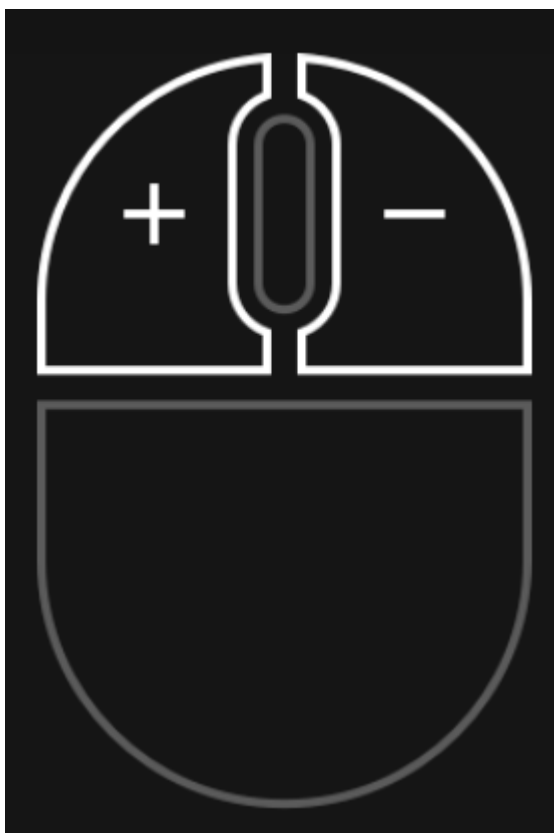

Manual nodule segmentation correction tool.

Here the user can adapt the automatic segmentation manually, by clicking the left and right mouse button as marked in the image.

"-" click and hold this button while moving over the parts of the segmentation which should be excluded from the volume segmentation

"+" click and hold this button while moving over the parts of the segmentation which should be included into the volume segmentation

**„Reset || Undo“**

Click Undo to jump back one step in the nodule adjustment. Reset goes back to the initial view.

**„Accept nodule“**

Accepts nodule segmentation and jumps to ACR-TIRADs menu.

**„Discard nodule“**

Nodule is discarded and nodule menu is exited.

Composition  
(2) Solid or almost completely solid

Echogenicity  
(0) Anechoic

Shape  
(0) Wider-than-tall

Margin  
(0) Ill-defined

ACR TI-RADS Echogenic Foci

(0) None or large comet-tail artifacts

(1) Macrocalcifications

(2) Peripheral calcifications

(3) Punctate echogenic foci

The software suggests:

Composition

(0) Cystic or almost completely cystic

(0) Spongiform

(1) Mixed cystic and solid

(2) Solid or almost completely solid

Echogenicity

(0) Anechoic

(1) Hyperechoic or isoechoic c

(2) Hypoechoic

(3) Very hypoechoic

Shape

(0) Wider-than-tall

(3) Taller-than-wide

Margin

(0) Ill-defined

(0) Smooth

(2) Lobulated or irregular

(3) Extra-thyroidal extension

ACR TI-RADS Echogenic Foci

(0) None or large comet-tail artifacts

(1) Macrocalcifications

(2) Peripheral calcifications

(3) Punctate echogenic foci

After reviewing and maybe adjusting, accept the selection.

**"Accept"**

**"Skip"**

Accepts the selected ACR-TIRADs points and the calculated TIRADs level.

Skips the ACR-TIRADs evaluation and shows only the nodule volume.

**Nodule 1** [edit] [delete]

Volume: 2.7 ml  
 Max. diameter: 2.6 cm  
 Cystic volume: 0.6 ml  
 ACR TI-RADS LEVEL 4 (5 points)  
 FNA recommended

**Nodule 1** [edit] [delete]

Volume: 2.4 ml  
 Max. diameter: 2.4 cm  
 Cystic volume: 0.5 ml  
 ACR TI-RADS LEVEL 3 (3 points)  
 Follow up recommended

**Nodule 1** [edit] [delete]

Volume: 2.5 ml  
 Max. diameter: 2.5 cm  
 Cystic volume: 0.5 ml  
 ACR TI-RADS LEVEL 2 (2 points)  
 No FNA, no follow up recommended

Overview of the nodule, including

- Volume
- Maximal diameter
- Cystic volume
- ACR TI-RADS Level
- FNA/ Follow-up recommendation

Three recommendations for Nodule are available:

1. FNA recommended
2. Follow up recommended
3. No FNA, no follow up recommended Delete or edit the shown nodule.

The arrow let you jump between multiple nodules.



5.6.2.5 Annotation menu

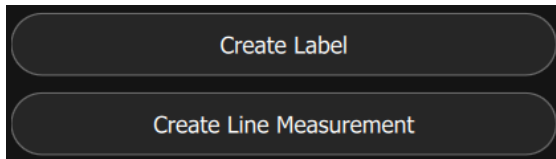

Choose between Label and Line Measurements.

**„Label“**

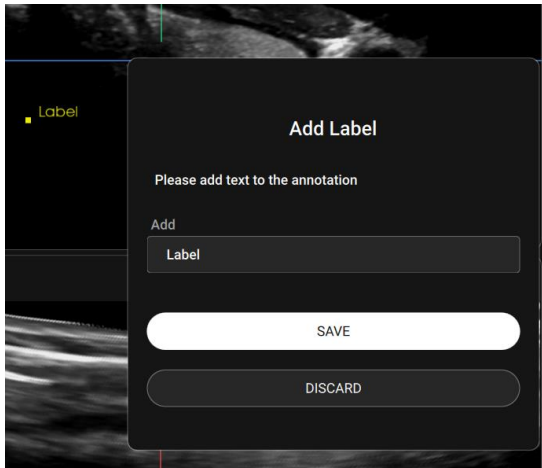

Target the marker in the MPR planes.  
Change Label name, discard or save.

**„Line Measurement“**

Target the first measurement pint in the MPR plane.

Click the second point to finish the measurement.

The measured value is displayed next to the measurement line.

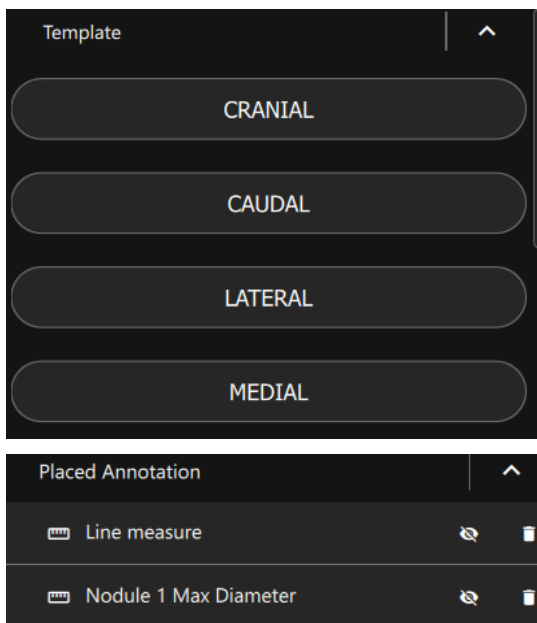

Select a predefined Label and place it in the MPR plane.

Placed annotations are listed.

Select each annotation by the checkbox.



Disable / Enable selected annotations.



Delete selected annotations.

Labels can be created in the transversal, sagittal and frontal MPR plane. A yellow point in the 3D representation marks the current position of your mouse pointer within the 3D volume. Similarly, the points you set in in the MPR planes are displayed in real-time in the 3D representation.

It is possible to draw annotations across several planes. During creation, the MPR planes can be switched with the mouse wheel or scrollbar for this purpose. In addition, points can be set in all three MPR planes.

It is possible to translate the three MPR images during the annotation creation process without ending it.

#### 5.6.2.6 Screenshot menu

##### „2D Screenshot“

2D Screenshot is taken and can be saved or discarded.



Select / unselect all checkboxes.



Delete selected screenshots.

#### 5.6.2.7 Report menu

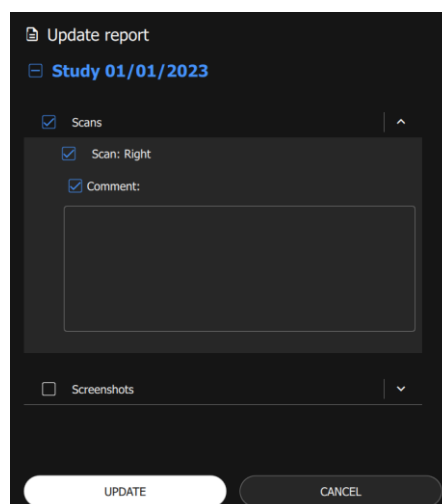

Figure 15: Dialogue „Update report“

**“Generate Report”**

Opens pop-up window to select the content of the report. Max. 1 right and 1 left scan can be added to the report.

**„Update Report“**

Opens pop-up window to update the content of the report.

**„Cancel“**

Terminates the process without storage

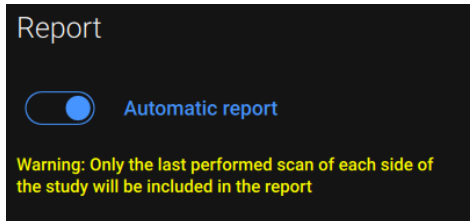

In the settings, the automatic report generation can be activated. Only the last performed scan of each side (left and right) of the study will be included in the report.

Every change in the Analysis will be saved automatically in the report after clicking “accept nodule” / “accept lobe” / “accept”.

---

## 6 PIUR tUS Infinity: Commencing Operation and Conducting the Examination

---

### 6.1 Moving the Ultrasound Probe with PIUR tUS Infinity

---

The ultrasound probe can also be used for regular ultrasound examinations with the PIUR attachment mounted before and after 3D acquisition.

#### Requirements for performing a scan

Make sure the Infinity Sensor is active by pressing the switch button

The following movement patterns **are highly recommended** in order to receive an accurate image:

1. Move the probe with a scan speed of **1-2 cm/s**
2. Start the movement once you heard the audio feedback signal after pressing the start button to avoid missing data caused by a transmission delay. Make sure that the sound of the Laptop is turned on and the sound is enabled in the acquisition menu (5.5).

Certain movement patterns during acquisition have proven to be especially advantageous for optimal 3D reconstruction:

1. During acquisition, move the probe with as steadily and fluid movements as possible along the neck
2. Move the probe linearly over the neck to be represented during acquisition. Avoid extreme sideward movements of the probe.
3. Avoid keeping the probe at one spot without any movement
4. Avoid side movements without any transversal movement along the thyroid
5. Avoid changing hands for holding the probe during acquisition



**Information:** The Infinity Sensor goes into sleep mode after 10 minutes without use and thus no longer transmits any information.

**If you start recording again more than five minutes, turn the sensor back on beforehand.**

---

### 6.2 Parameter settings of the Ultrasound device

---

The image parameters on the ultrasound device can be set as normal as for classical 2D examinations on the thyroid.

---

## 7 Taking out of Operation

---

### 7.1 Switching Off and Storing the Device

---

The application is shut down by the Ultrasound environment.  
Ensure you saved all relevant information.

---

### 7.2 Charging and Storing the Device

---

Charging of PIUR Sensor is done wirelessly.

1. Place PIUR Sensor on a charging pad.
2. A charging label printed on the bottom of PIUR Sensor must align with the center of the charging pad.



Figure 16: PIUR Sensor on a charging pad

LED feedback:

**Illumination**

- Blinking green
- Static green

**Information about system status**

On the charging pad, battery is charging

On the charging pad, battery is fully charged

---

## 7.3 Disinfecting and Cleaning

---

### 7.3.1 Removing and Cleaning the PIUR Sensor

The PIUR Sensor must be cleaned before and after each use in accordance with the applicable disinfection and cleaning rules.

1. Remove the sensor housing from the attachment plate by levering it diagonally downwards with one hand.



2. Carefully remove all soiling and residues from the sensor housing, using a soft damp cloth if necessary.
3. Wipe the sensor surface with CaviWipes™.
4. Let the sensor dry for about 2 minutes.



#### Safety Notice

Never submerge the PIUR sensor in disinfectant or any other liquid. Submerging of the component results in a loss of warranty and may cause damage to the system and endanger the patient. If these components are accidentally submerged into any substance, please contact the manufacturer.

### 7.3.2 Removing and Cleaning the Bracket

Clean and disinfect the attachment after every patient examination, as follows:

1. Release the attachment from the anchoring by applying slight pressure to the attachment plate and remove it from the ultrasound probe.



2. Wipe attachment, with CaviWipes™.
3. Let the attachment dry for about 2 minutes.



**Safety Notice**

Never sterilize (e.g. autoclave) the components of the system. Sterilization of any of these components results in a loss of warranty and can cause damage to the system and endanger the patient. If these components are accidentally sterilized, please contact the manufacturer.

**Before starting cleaning and disinfection, please note the following:**

- None of the (electrical) components shall have any visible damage; otherwise, water or cleaning/disinfection solution could penetrate. This could cause malfunctions or damage to the electrical components.
- Do not apply diving cleaning or disinfection.

Strictly follow the application instructions specified on the detergent used, disinfectant!

In accordance with the statutory hygiene regulations for the prevention of infections and the requirements for the treatment of medical devices, a careful and effective cleaning and disinfection must be carried out after each use.

If coarse impurities are visible, they must be removed with an appropriate cleaner (or disinfectant cleaner) before disinfection.

Appropriate means of disinfection must be used, the material compatibility of which has been demonstrated:

<b>Active ingredient</b>	Quaternary ammonium germicidal detergent solution
<b>Cleaning Agents</b>	CaviWipes™ (Disinfectant Wipes)
<b>Dry time</b>	2 Minutes

**WARNING:** Do not use any liquid or aerosol cleaner, only determined cleaning solution (agent) specified above.

### 7.3.3 Cleaning and Disinfecting of the remote control and computer

Please follow the instructions given in the user manual of the devices.

---

## 7.4 Disposing of PIUR tUS Infinity Hardware

---

The system must be disposed in accordance with the national guidelines for electronic scrap. Alternatively, the device can be sent back to the manufacturer for disposal.

---

## 7.5 Disposal of software and data

---

To uninstall the PIUR software from the computer, use the built-in Windows function "Add or remove programs" to run the PIUR uninstaller. Please note that this removes the PIUR software only, acquired image and patient data will remain on the hard drive. To delete all image and patient data from the hard drive permanently, delete the folder "piur imaging" located in the installation drive. Make sure that the data does not remain in the Windows Recycle Bin. It is recommended to perform a full backup of the data beforehand, since this process cannot be undone.



---

## 8 Service and Maintenance

---

### 8.1 Backup and recovery of patient data

---

Use the backup function described in 5.4.2 to perform regular backups of the database.

To recover the database, copy all files of your backup folder into "piur imaging/acquisitions" located in the installation drive. The database can only be recovered as a whole. In case you want to restore single patient information, contact the service personnel.

---

### 8.2 Contact

---

service@piurimaging.com

Hotline: +43-12 650 16 8

Please write down the serial number of your system before contacting our service team. You can find the serial number on the identification label at bottom of the PIUR tUS Infinity system (see chapter 1.3.1).

---

### 8.3 Maintenance Interval

---

PIUR tUS Infinity does not require regular maintenance.



**Information:** Batteries Cycle Life at room temperature may drop to 80% of minimum capacity after 500 cycles or 2 years (depending on charging).

Infinity Sensor will anyway indicate when batteries are depleted.

---

### 8.4 Software Update

---

The user is not permitted to carry out software updates. Software updates are performed by trained service personnel.

---

## 8.5 Procedure in Case of Faults and Defects

---



**Safety Notice:** If malfunctions and defects occur.

**Occurrence of malfunctions and defects can lead to personal injury or damage to the device.**

- If malfunctions and defects occur, discontinue the use of the PIUR tUS Infinity system and inform our service team via the above contact details.

## 9 Technical Data

### 9.1 General data

	Infinity Box	Infinity Sensor
<b>Voltage</b>	19 VDC Power supply: 100-240 V 50/60 Hz	3,7 VDC (Lithium Polymer)
<b>Dimensions</b>	260x160x65 mm	41,7 x 56,2 x 25,3mm
<b>Mass (without packaging)</b>	0,8 kg power supply: 0,7 kg	40 g
<b>Lifetime</b>	5 years	2 years
<b>Storage and transport condition</b>	Temperature: - Storage < 3 months: -20 to 40 °C - Recommended storage > 3 months: 0 to 30 °C Relative humidity: Maximum 65 % Air pressure: 500 hPa to 1060 hPa	
<b>Operating conditions</b>	Temperature: 0 °C to +30 °C Relative Humidity: 30 % to 65 % Air pressure: 70kPa to 106 kPa	
<b>Operating altitude</b>	Maximal 2000 m	

### 9.2 Technical characteristics and performance data

#### 9.2.1 Measurement Function

The length of Line and Curve is shown beside the label.



**Safety Notice:** Accurate measurements can only be performed in the "Performance"-Domain of Tracking Sensor à same room

In case of leaving the "Performance"-Domain during a measurement a warning will appear.

Check if all parameters as Depth, Transducer and US Device are set correctly in the Acquisition-Mode (use autodetection if possible) before recording (5.5).

PIUR tUS Infinity allows three-dimensional measurements within the reconstructed volume.

Measurement possibilities are:

- Line measurement
- Spline measurement
- Volume measurement

The system accuracy is determined by a percental measurement error computed relative to the ground truth. The protocol measures volume of known dimensions and the systems calculated value is compared to the known ground truth. The details can be found in the accuracy validation study performed.

- **Volumetric accuracy G2 sensor:** considered as volume measurement using all three dimensions of the dataset  
Relative measurement error: Mean 9.49 %, Median 17.12%
- **Volumetric accuracy G3 sensor:** considered as volume measurement using all three dimensions of the dataset  
Relative measurement error: Mean 4.73%, Median 6.79 %

The volumetric accuracy contains the ultrasounds intrinsic accuracy, the compound volumetric error might vary for ultrasound machines with bad intrinsic image resolution compared to the markets average accuracy.

Note: This device has no essential performance according to EN 60601-1:2006+AMD2:2021.

---

### 9.3 Classification

---

	<b>Video Box</b>	<b>Sensor</b>
Protection class	Power supply: Class I	Internally powered device
IP classification	IP2X requirements fulfilled	IPx5

---

## 9.4 Electromagnetic compatibility (EMC)

---

The Infinity Box and Infinity Sensor fulfil the requirements of the standards:

- EN 60601-1-2:2015
- EN 60601-2-37:2016
- EN 301 489-1 V2.2.3 (2019-11) and
- EN 301 489-17 V3.2.4 (2020-09)

These components are classified according to CISPR 11 as group 1, class B.

	<b>Video Box</b>	<b>Sensor</b>
Frequency band of reception	2,4 GHz and 5 GHz (160 MHz channels)	2,4 GHz ISM frequency band
Bandwidth of the receiving section	max. 1.73 Gbit/s	max. 1 Mbit/s
Frequency band of transmission	2,4 GHz and 5 GHz (160 MHz channels)	2,4 GHz ISM frequency band
Type and frequency characteristics of the modulation	IEEE 802.11a/b/g/n/ac	IEEE 802.15.1
Effective radiated power	max. 23dBm	5 dBm